

model **GRIGLIA**

cod 37,5 x h. 40,5 cm

1539

cod 25 x h. 39 cm

1556

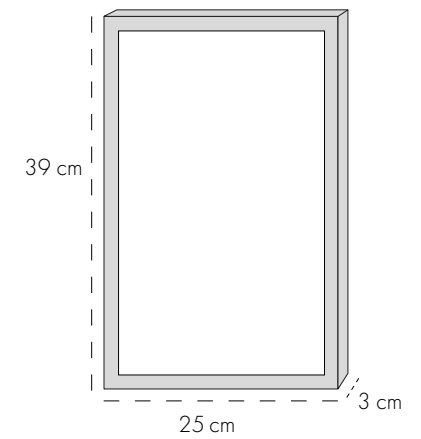
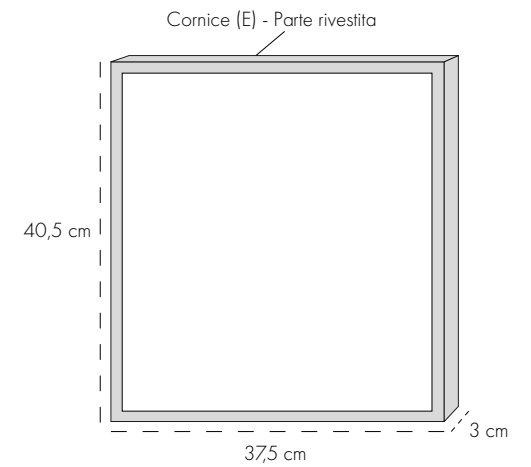

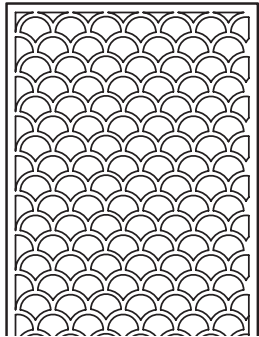

modello 1

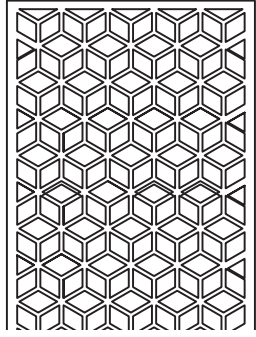

modello 2

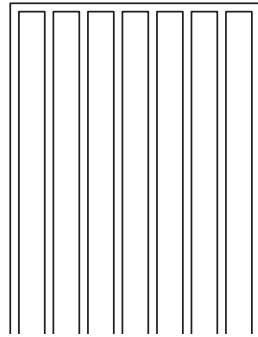

modello 3

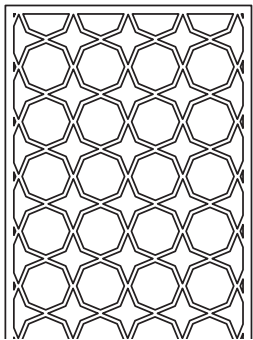

modello 4

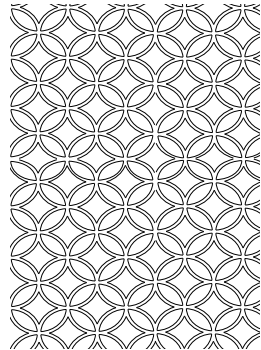

modello 6

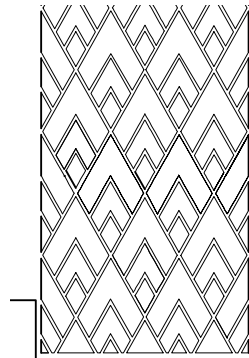

modello 7

model GRIGLIE

